



JPCR6012SL

EPI PLANAR HYPERFAST SOFT RECOVERY RECTIFIER

Rev.1.3

DESCRIPTION

- ✧ Plastic package has underwriters laboratory flammability classification 94V-0
- ✧ Lead free in comply with EU RoHS 2011/65/EU directives
- ✧ Low reverse leakage current
- ✧ Hyperfast recovery time
- ✧ Epitaxial planar technology
- ✧ 5th Generation soft fast recovery characteristics
- ✧ Low recovery loss

MECHANICAL DATA

- ✧ Case: TO-247J-2L molded plastic
- ✧ Terminals: Solder plated, solderable per J-STD-002
- ✧ Weight:5.75gram

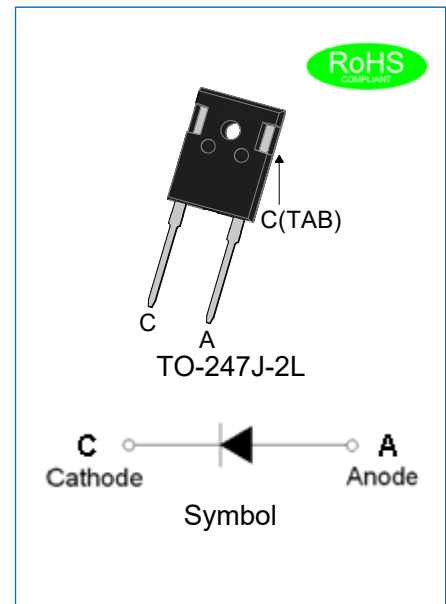

ABSOLUTE MAXIMUM RATING (Rating at 25°C ambient temperature unless otherwise specified.)

Parameter	Symbol	JPCR6012SL	Unit
Maximum repetitive peak reverse voltage	V_{RRM}	1200	V
Maximum RMS voltage	V_{RMS}	840	V
Maximum DC blocking voltage	V_{DC}	1200	V
Average forward current at $T_C=105^\circ\text{C}$	$I_{F(AV)}$	60	A
Peak forward surge current: 10ms single half sine-wave superimposed on rated load	I_{FSM}	540	A
Junction temperature and storage temperature range	T_j, T_{stg}	-55 to +175	$^\circ\text{C}$

ELECTRICAL CHARACTERISTICS(Rating at 25°C ambient temperature unless otherwise specified)

Parameter		Symbol	Min.	Typ.	Max.	Unit
Forward voltage	$I_F=60A, T_j=25^\circ C$	V_F	-	2.8	3.3	V
	$I_F=60A, T_j=150^\circ C$		-	1.9	3.0	
Reverse current	$V_R=1200V, T_j=25^\circ C$	I_R	-	-	10	μA
	$V_R=1200V, T_j=150^\circ C$		-	-	1	mA
Reverse recovery time	$I_F=1A, V_R=30V,$ $di_F/dt=200A/\mu s, T_j=25^\circ C$	t_{rr}	-	34	-	ns
	$I_F=50A, V_R=400V,$ $di_F/dt=200A/\mu s, T_j=25^\circ C$		-	110	-	
	$I_F=50A, V_R=400V,$ $di_F/dt=200A/\mu s, T_j=125^\circ C$		-	255	-	
Reverse recovery current	$I_F=50A, V_R=400V,$ $di_F/dt=200A/\mu s, T_j=25^\circ C$	I_{RRM}	-	6.4	-	A
	$I_F=50A, V_R=400V,$ $di_F/dt=200A/\mu s, T_j=125^\circ C$		-	17	-	
Reverse recovery charge	$I_F=50A, V_R=400V,$ $di_F/dt=200A/\mu s, T_j=25^\circ C$	Q_{rr}	-	420	-	nC
	$I_F=50A, V_R=400V,$ $di_F/dt=200A/\mu s, T_j=125^\circ C$		-	2570	-	

THERMAL RESISTANCES

Symbol	Parameter	Min.	Typ.	Max.	Unit
$R_{th(j-c)}$	Thermal resistance from junction to case	-	-	0.4	$^\circ C/W$

MARKING

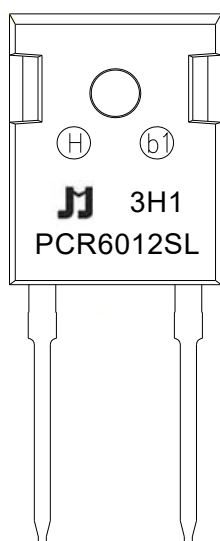

PCR	Planar Hyperfast Recovery Rectifier
60	$I_{F(AV)}=60A$
12	$V_{RRM}:1200V$
SL	Package:TO-247J-2L

$xH1$: Month, 1/2/3~9/A/B/C

$3x1$:

2018	2019	2020	2021	2022	2023	2024
H	I	J	K	L	M	N
2025	2026	2027	2028	2029	2030	...
O	P	Q	R	S	T	...

$3Hx$: Batch number

ORDERING INFORMATION

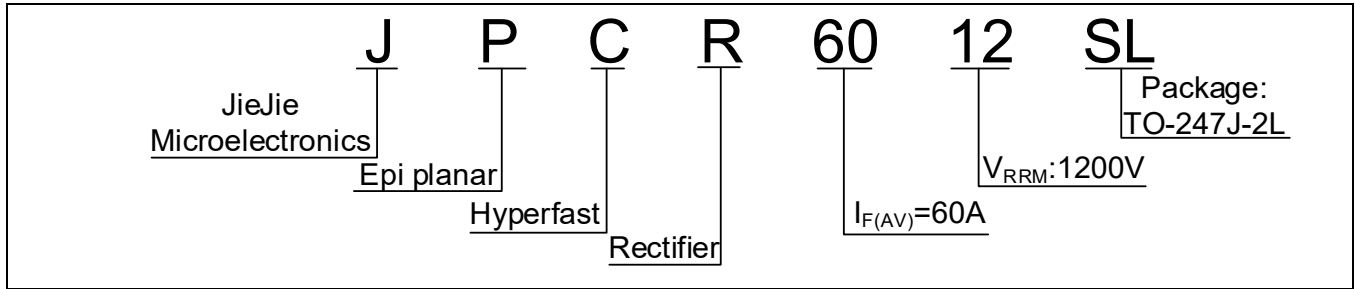

PACKAGE MECHANICAL DATA

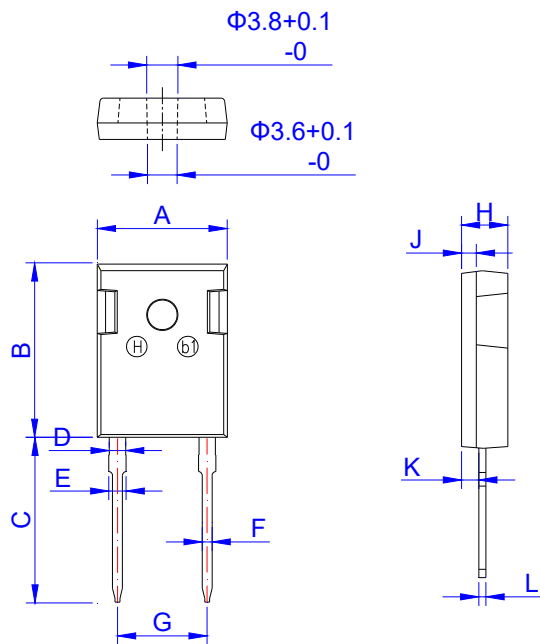

TO-247J-2L

Ref.	Dimensions					
	Millimeters			Inches		
	Min.	Typ.	Max.	Min.	Typ.	Max.
A	15.50	15.80	16.10	0.610	0.622	0.634
B	20.80	21.00	21.20	0.819	0.827	0.835
C	19.70	20.00	20.30	0.776	0.787	0.799
D	1.80	2.00	2.20	0.071	0.079	0.087
E	1.90	2.10	2.30	0.075	0.083	0.091
F	1.00	1.20	1.40	0.039	0.047	0.055
G	10.50		11.30	0.413		0.445
H	4.80	5.00	5.20	0.189	0.197	0.205
J	1.90	2.00	2.10	0.075	0.079	0.083
K	2.20	2.35	2.50	0.087	0.093	0.098
L	0.41	0.60	0.79	0.016	0.024	0.031

PACKAGE INFORMATION-TO-247J-2L

OUTLINE	UNIT WEIGHT (g/PCS) TYP	TUBE (PCS)	PER CARTON (PCS)
TUBE	5.75	30	2,250

CHARACTERISTICS CURVE

FIG.1 Typical forward characteristics

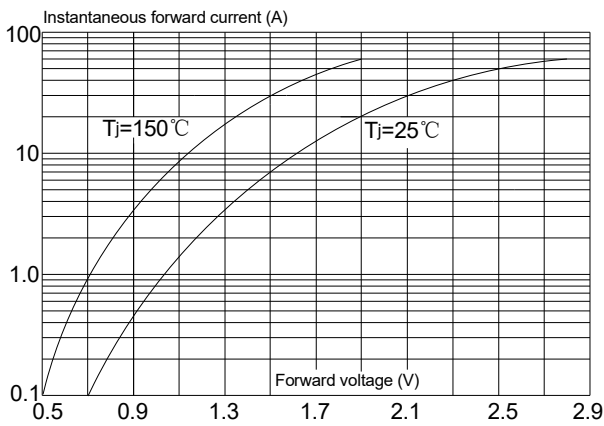

FIG.2 Typical reverse characteristics

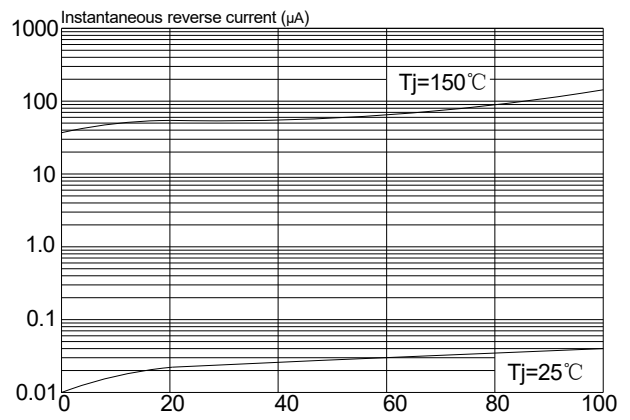

FIG.3 Maximum non-repetitive peak forward surge current(10ms single half sine-wave)

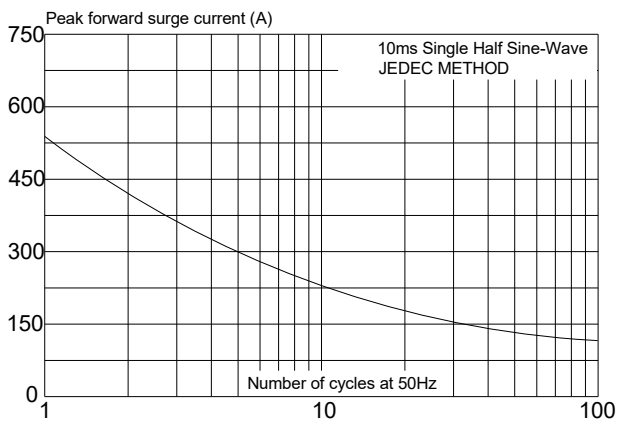

FIG.4: Forward current derating curve

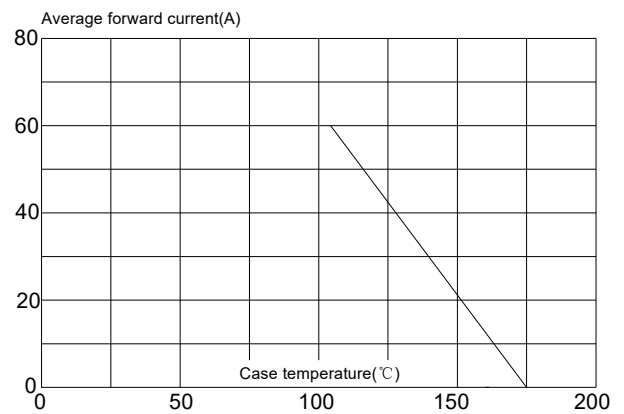
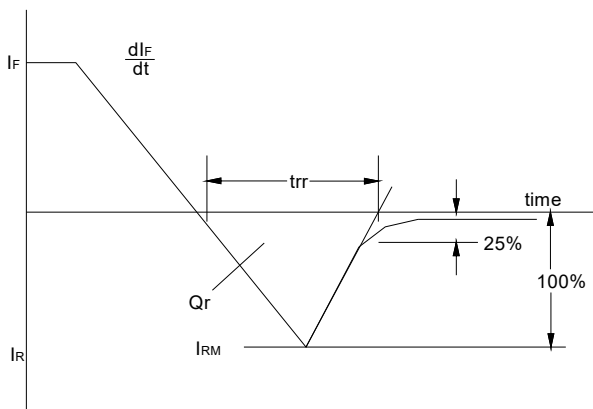

FIG.5: Reverse recovery definitions



JieJie products are not designed for, and shall not be used for, any purpose (including, without limitation, automotive, military, aerospace, medical, life-saving, life-sustaining or nuclear facility applications, devices intended for surgical implant into the body, or any other application in which the failure or lack of desired operation of the product may result in personal injury, death, or property damage) other than those expressly set forth in applicable JieJie product documentation. Warranties granted by JieJie shall be deemed void for products used for any purpose not expressly set forth in applicable JieJie documentation. JieJie shall not be liable for any claims or damages arising out of products used in applications not expressly intended by JieJie as set forth in applicable JieJie documentation. The sale and use of JieJie products is subject to JieJie terms and conditions of sale, unless otherwise agreed by JieJie.

Information furnished in this document is believed to be accurate and reliable. However, Jiangsu JieJie Microelectronics Co., Ltd. assumes no responsibility for the consequences of use without consideration for such information nor use beyond it.

Information mentioned in this document is subject to change without notice, apart from that when an agreement is signed, Jiangsu JieJie complies with the agreement.

Products and information provided in this document have no infringement of patents. Jiangsu JieJie assumes no responsibility for any infringement of other rights of third parties which may result from the use of such products and information.

This document is the 1.3rd version which is made in 27-Mar.-2024. This document supersedes and replaces all information previously supplied.

 is a registered trademark of Jiangsu JieJie Microelectronics Co., Ltd.

Copyright ©2024 Jiangsu JieJie Microelectronics Co., Ltd. Printed All rights reserved.